



50 Watt RQF Single Series



- Designed specifically for Railway Applications
- Input voltages of 72 (43-101)VDC or 110 (66-160)VDC
- Efficiency up to 92%
- 3000VAC_{RMS} Isolation
- MTBF > 314,000 Hours
- Overload Protection
- Over Temperature Protection
- Under Voltage Shutdown
- Remote On/Off
- No Minimum Load Requirement
- Optional Heatsink
- RoHS Compliant



Model Number	Voltage			Current			Overvoltage Protection (VDC)	Reflected Ripple Current (mA (Typ))	Efficiency (@ Max Load (%), Typ)	Capacitive Load (Max (Dual each output))
	Input		Output	Input		Output				
	Nom. (VDC)	Range (VDC)	(VDC)	@ No Load (mA)	@ Max Load (mA)	Max (mA)				
RQF50J72S5	72	43 - 101	5	50	771	10000	6.2	35	90	17000µF
RQF50J72S12	72	43 - 101	12	45	755	4170	15	35	92	2950µF
RQF50J72S15	72	43 - 101	15	45	754	3330	18	35	92	1900µF
RQF50J72S24	72	43 - 101	24	50	762	2080	30	35	91	740µF
RQF50J110S5	110	66 - 160	5	40	505	10000	6.2	35	90	17000µF
RQF50J110S12	110	66 - 160	12	35	500	4170	15	35	91	2950µF
RQF50J110S15	110	66 - 160	15	35	494	3330	18	35	92	1900µF
RQF50J110S24	110	66 - 160	24	40	499	2080	30	35	91	740µF

To order optional Heatsink - add -HS to part number when ordering

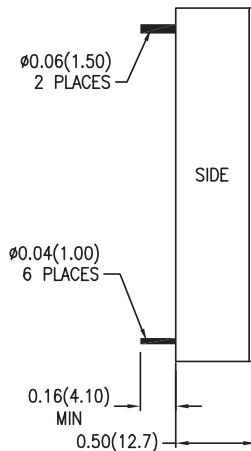
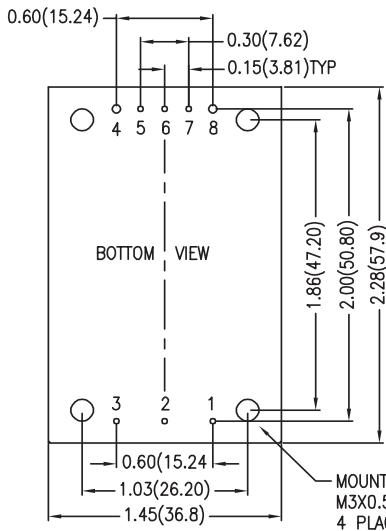

Optional Heatsink (-HS)

To order with heatsink add -HS to model number

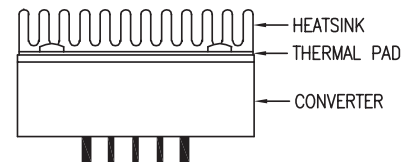
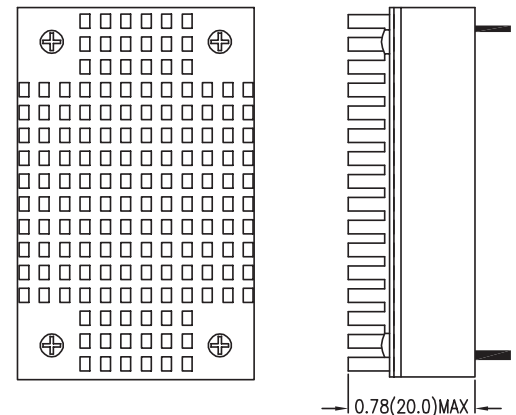

Black Anodized Aluminum
Weight: 13 grams

Pin Connections	
Pin	Function
1	+ Vin
2	Remote On/Off
3	- Vin
4	-Vout
5	-Sense*
6	Trim
7	+Sense*
8	+Vout

Dimensions are inches (mm) unless noted

Tolerance: Inches	Millimeters
X.XX ±0.02	X.X ±0.5
X.XXX ±0.001	X.XX ±0.25
Pin ±0.002	±0.05

* If remote sense is not used the +Sense should be connected to +output and -Sense should be connected to -output. Maximum output deviation is 10% inclusive of trim.



See Model Selection Table for Model Specific Parameters

Input Parameters	Min	Typ	Max	Units
Input Surge Voltage (100ms max.) 72 Vin 110 Vin	-0.7 -0.7		165 250	VDC
Startup Threshold Voltage 72 Vin 110 Vin			43 66	VDC
Under Voltage Shutdown 72 Vin 110 Vin		40 63		VDC
Start-up Time		0.35		S
Switching Frequency		320		kHz
Input Filter	Internal Pi Network			
Conducted EMI	Meets EN 55022, EN55011, FCC part 15, Class A			
Output Parameters	Min	Typ	Max	Units
Output Voltage Accuracy at Full Load and Nom Vin			±1.0	%
Load Regulation Min. Load to Full Load			±0.3	%
Line Regulation Vin=Min. to Max. @ Full Load			±0.2	%
Ripple & Noise (20MHz) 24 V Models All other Models			150 100	mV P-P
Transient Recovery Time 25% Load Step Change		250		µs
Transient Response Deviation		±3	±5	%
Temperature Coefficient			±0.02	% / °C
Over Current Protection	Current limitation at 150% typ of Iout max., Hiccup			
Short Circuit Protection	Hiccup mode 0.5Hz typ.			
General Specifications	Min	Typ	Max	Units
Isolation Voltage, 60 seconds (reinforced insulation)	3000			VACrms
Insulation Voltage Input/Output to case	1500			VDC
Isolation Resistance 500VDC	1000			Mohms
Isolation Capacitance, 100kHz, 1V			3000	pF
Temperature	Min	Max w/o heatsink	Max with Heatsink	Units
Operating Temperature Natural Convection, Vin nom, Load 100% Inom. Power derating see derating curves.				
XX.72S12, XX.72S15, XX.110S15	-40	+72	+75	°C
XX.72S24, XX.110S12, XX.110S24	-40	+68	+71	°C
XX.S72S5, XX.110S5	-40	+63	+67	°C
	Min	Typ	Max	Units
Thermal Impedance Natural Convection without heatsink with heatsink	7.5 6.8			°C/W

Baseplate Temperature Range	-40		+105	°C
Over Temperature Protection (Baseplate)			+110	°C
Storage Temperature	-50		+125	°C
Humidity (Operating)	5		95	%
MTBF MIL-HDBK-217F @25°C, Ground Benign	314			k Hours
Cooling	Free-Air Convection			
Case Size	2.28 x 1.45 x 0.50 inches 57.9 x 36.8 x 12.7 mm			
Case Material	Non-Conductive Black Plastic (UL94V-0) and Aluminum Base Plate			
Weight (Converter only)	61g			
Agency Approvals (Pending)	UL60950-1, EN50155			

Remote On/Off Control	Min	Typ	Max	Units
DC/DC On	3.5V - 12V or Open Circuit			
DC/DC Off	0V - 1.2V or Short Circuit			
Control Input Current (on) Vctrl = 5.0V		0.5		mA
Control Input Current (off) Vctrl = 0 V		-0.5		mA
Control Common	Referenced to Negative Input			
Standby Input Current Nominal Vin		2.5		mA
Output Voltage Trim	Min	Typ	Max	Units
Trim Up / Down Range % of nominal output voltage	% of nominal output voltage ±10%			

Notes:

1. Specifications typical at Ta=+25°C, resistive load, nominal input voltage and rated output current unless otherwise noted.
2. Ripple & Noise measurement with a 1µF MLCC and a 10µF Tantalum Capacitor.
3. Transient recovery time is measured to within 1% error band for a step change in output load 75% to 100%.
4. Water washability - ConTech DC/DC converters are designed to withstand most solder/wash processes. Careful attention should be used when assessing the applicability in your specific manufacturing process. Converters are not hermetically sealed.
5. Natural Convection is about 20 LFM but is not equal to still air. (0 LFM)
6. See ConTech website for Definition of Terms, Application Notes, and Test Setups and Parameters. www.ConTech-us.com/appnotes.html.
7. Specifications subject to change without notice.
8. See ConTech website www.ConTech-us.com/pdf/rohs.pdf for RoHS Statement.

Derating Curves

50 Watt RQF

Without Heatsink

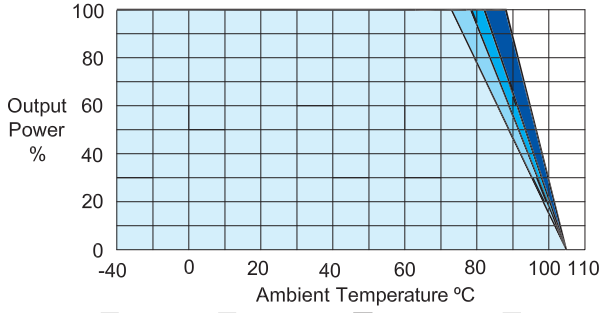

Models: RQF50J72S12, RQF50J72S15, RQF50J110S15

With Heatsink

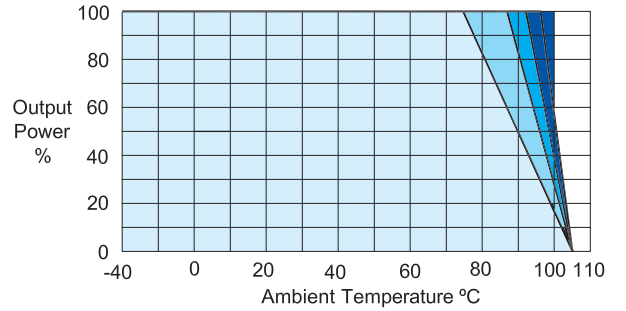

Models: RQF50J72S12, RQF50J72S15, RQF50J110S15

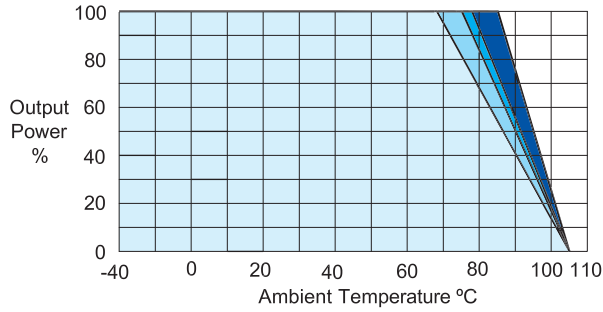

Models: RQF50J72S24, RQF50J110S12, RQF50J110S24

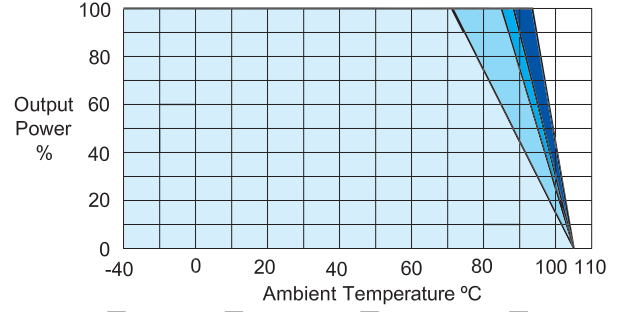

Models: RQF50J72S24, RQF50J110S12, RQF50J110S24

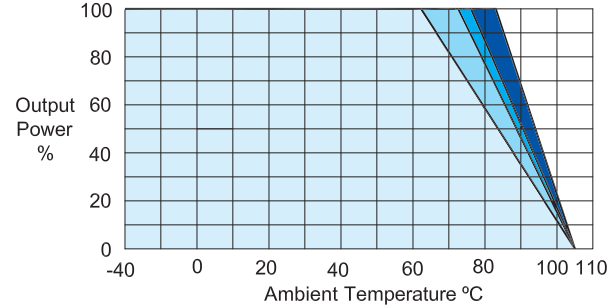

Models: RQF50J72S5, RQF50J110S5,

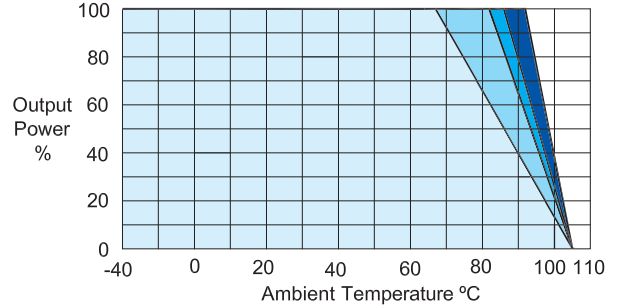

Models: RQF50J72S5, RQF50J110S5

External Output Trimming:

Output can be trimmed using the method below.

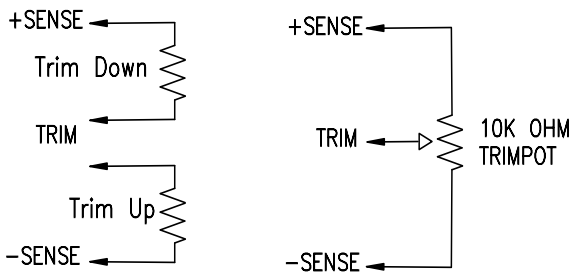

Recommended Filter: for EN55011 & 55022, Class A: FCC part 15, level A Compliance

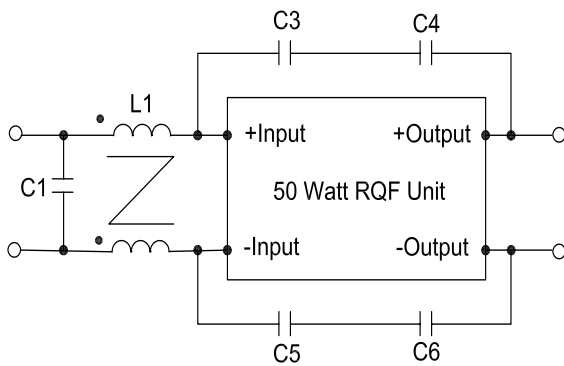

Model	L1	C1	C3, C4, C5 & C6
72SXX 110SXX	450 μ H/ 450 μ H	Chemi-Con KXG Series 68 μ F/200V	2200pF 3KV